

**ARTHUR**

**Standard Features:**

- Advanced unidirectional suspension system
- Premium high-density, high-resiliency foam seat cushions
- Loose back cushions
- Semi-attached seat cushions
- Single-needle top-stitch
- Lifetime warranty on frame and suspension
- 5 year foam and cover warranty
- 3 year mechanism warranty
- Quick-ship delivery

**Options:**

- Premium high-density, high-resiliency foam bench seat cushion
- Premium high-density, high-resiliency foam bench seat cushion with memory foam encased in down
- Premium high-density, high-resiliency foam seat cushions with memory foam encased in down
- Loose down-filled back cushions
- Low leg available with black plastic leg
- High leg available with wood leg in Acorn, Espresso and Walnut finish

Please use actual leather, fabric, Crypton®, Sunbrella® and Ultrasuede® swatches when specifying furniture as the colors shown may vary due to the printing process.

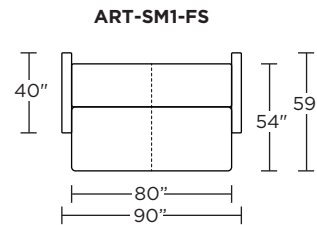
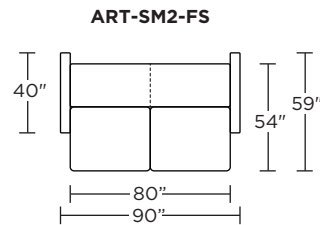
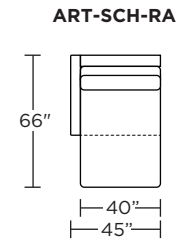
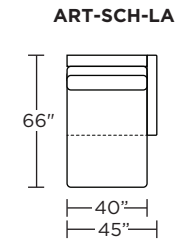
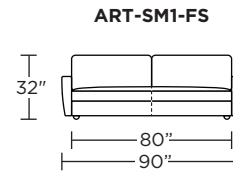
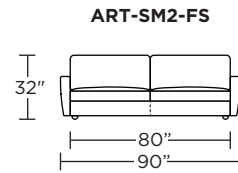

**STORAGE CHAISE:**

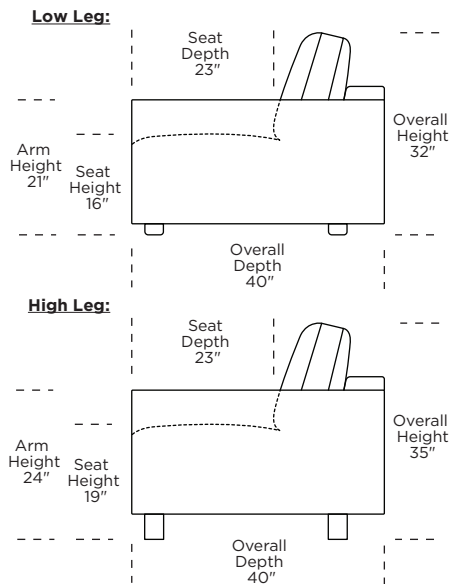
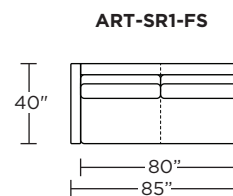
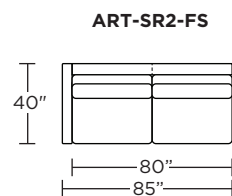
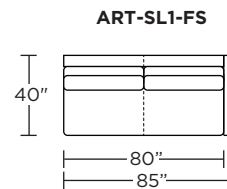
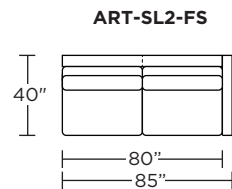
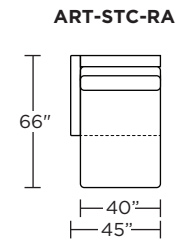
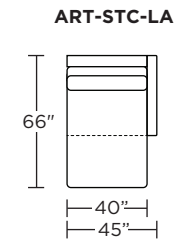

**Note:** Dotted line indicates seam on leather, Ultrasuede® and up the roll fabrics. Seams are eliminated with railroaded fabrics.

Scale: 1/4 inch = 1 foot  
All dimensions are approximate and subject to change.  
Specify components from the sitting position.