

# SOFAS & SECTIONALS COLLECTION

---

## DANFORD



**AMERICAN  
LEATHER**

# AMERICAN LEATHER® SOFAS & SECTIONALS COLLECTION

## DANFORD

### Standard Features:

- Advanced unidirectional suspension system
- Premium high-density, high-resiliency foam seats encased in down
- Quick-ship delivery
- Lifetime warranty on frame & suspension
- Loose back & seat cushions
- Double-needle top-stitching using thick thread

### Options:

- Wood legs available in Acorn, Espresso or Walnut finish
- Premium high-density, high-resiliency foam
- Extra firm premium high-density, high-resiliency foam seats

Please use actual leather, fabric and Ultrasuede® swatches when specifying furniture as the colors shown may vary due to the printing process.

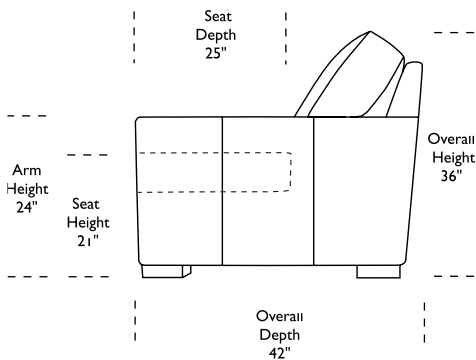

\*Note: arm height for this frame is measured at the highest point of the curved arm.

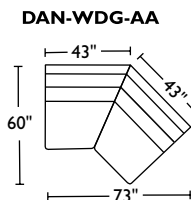
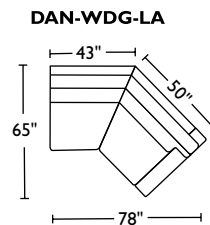
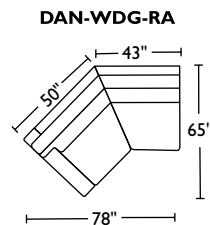
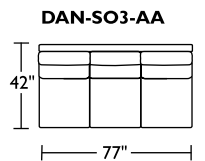
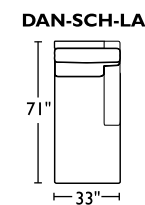
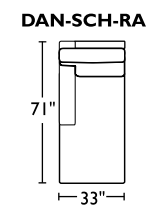
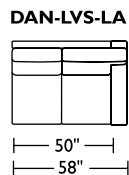
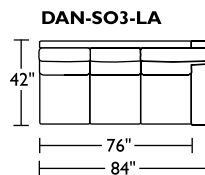
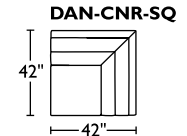
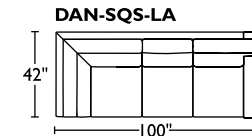
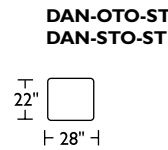
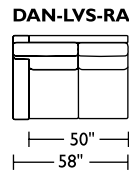
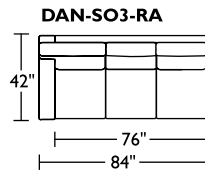
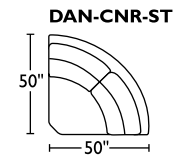
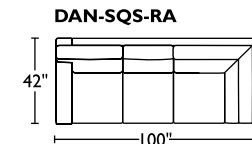
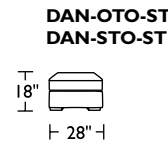
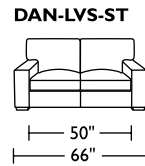
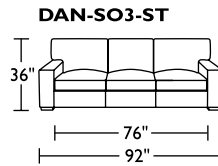

Scale: 1/8 inch = 1 foot

All dimensions are approximate and subject to change.  
Specify components from the sitting position.

V.04.18.14