

**Standard Recliner Features:**

- Premium high-density, high-resiliency foam seat cushion
- Semi-attached back cushion
- Tight seat cushion
- Articulating headrest
- LED backlit control panel with USB charging port
- Stainless steel cup holder with adjustable LED lighting
- Stainless steel footrest extension hides all mechanical linkages
- Quick ship delivery
- Lifetime warranty on frame
- Ten year warranty on mechanism
- Five year warranty on motor

**Options:**

- Two-tone contrast available  
(First tone includes outer shell and arms.  
Second tone includes headrest, back cushion, and seat cushion.)
- Stainless steel cup holder without LED lighting
- No cup holder
- Battery with one year warranty
- Extra firm seating option (Seat cushion, back cushion, and headrest)
- Headrest cover available

DEE-REC-ST



DEE-LVS-ST

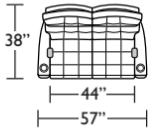

DEE-INS-06



DEE-REC-LA

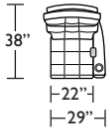

DEE-LVS-LA

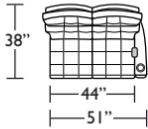

DEE-INS-09

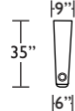

DEE-REC-RA

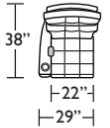

DEE-LVS-RA

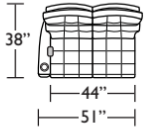

DEE-REC-AA

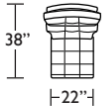

DEE-LVS-AA

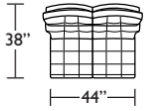

**Important Note:**

0 - This denotes power control box on arm

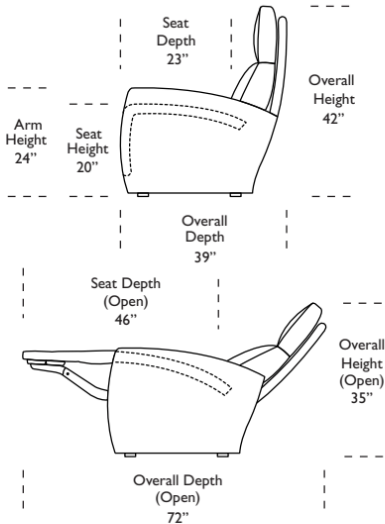

**Note:** Necessary Wall Clearance is 14"

U.S. Patent #8882190  
Additional patents pending

Scale : 1/8 inch = 1 foot  
All dimensions are approximate and subject to change.  
Specify all components from the sitting position.

V.05.11.16